

LEM

Life Energy Motion

Automotive

Leading technologies for automotive applications



Contents

- 4 Our customers and products**
- 6 Technologies**
- 8 12V battery management systems**
- 10 HV battery management systems**
- 14 Motor control**
- 18 Charging systems**
- 22 Contact**



Leading the world in electrical measurement

A leading company in electrical measurement, LEM engineers the best solutions for energy and mobility, ensuring that our customers' systems are optimized, reliable and safe.

Our 1,500 employees in more than 15 countries transform technology potential into powerful answers. We develop and recruit the best global talents, working at the forefront of mega trends such as renewable energy, mobility, automation and digitization.

With innovative electrical solutions, we are helping our customers and society accelerate the transition to a sustainable future.

Our customers and products

LEM partners with leading vehicle manufacturers and Tier 1 suppliers on powertrain electrification and autonomous driving applications by providing sensors that meet high standards of functional safety (ASIL).

LEM offers its customers a broad portfolio of products tailored to a wide range of technical requirements. LEM also prides itself on providing leading engineering services for customer-specific solutions.

Battery management

For start-stop vehicle architectures, we offer intelligent battery sensors combining a unique expertise in current sensing with more than 20 years experience in lead acid battery technologies.

In high voltage battery management (BMS HV), the CAB series brings the LEM expertise of the fluxgate technology to our customers.

The CAB series offer best-in-class accuracy and a high level of functional safety (ASIL) which avoids the installation of a redundant sensor.

We offer a broad range of single phase Hall open loop sensors for high compactness, fitted with an integrated busbar for cost effectiveness.

LEM developed dual range sensors with a dedicated low range to drastically improve offset performance while delivering very high accuracy.

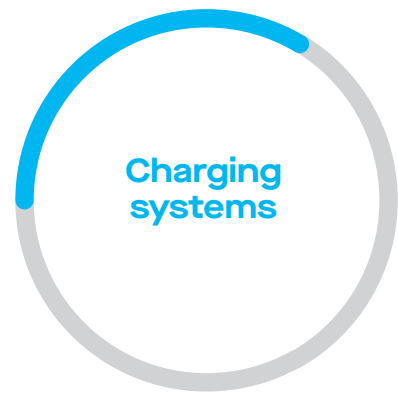

Motor control

The LEM sensors dedicated to power inverter applications provide flexible design to Original Equipment Manufacturers (OEMs) and Tier 1 suppliers as well as solutions compatible with various subsystems: printed circuit design (PCD) boards, power modules, integrated busbars, and standard busbar mountings.

Charging systems

LEM's newest product range brings technologies tailored to power management systems from AC to DC and DC to DC for high and low voltage applications. Future solutions dedicated to current leakage detection will meet the technical requirements for bi-directional on-board charging (OBC) and vehicle-to-grid/load (V2G & V2L). Our solutions will be ranging from 5mA to 300mA and guarantee high levels of safety for end-users, sanctioned by the ISO26262 ASIL certification, and the option to increase power density by removing reinforced insulation.

Technologies

LEM is committed to retaining technology leadership, continuously investing in R&D to deliver innovative products and solutions to customers, leveraging proven and cutting-edge technologies.

LEM sensors

Our current and voltage sensors are used in a wide range of applications: battery management and start-stop applications for conventional cars, electrical motor controls, battery pack management and charging systems for hybrid and electric vehicles.

Surface-mounted IC sensors

Power density is a critical factor for increasing performance, as space constraints are prevalent in virtually every automotive application. Ever increasing power densities are driving the emergence of new current sensing technologies. Surface-mounted integrated circuit (IC) sensors measure high currents in a very compact footprint and therefore have become the technology of choice.

Smarter sensors

Smart grid and autonomous driving are major disruptions caused by the digital revolution leading to smarter, greener and more efficient ecosystems. LEM is at the forefront of these megatrends, developing smart sensors equipped with data processing capabilities that insure higher safety levels thanks to self-diagnostic features. The LEM sensors feature embedded software that provides real time information to the on-board system, offering customers high-value and versatile solutions.

Hall open loop

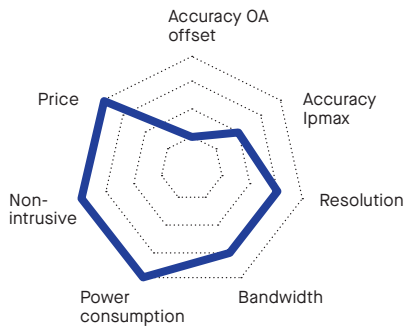

Shunt

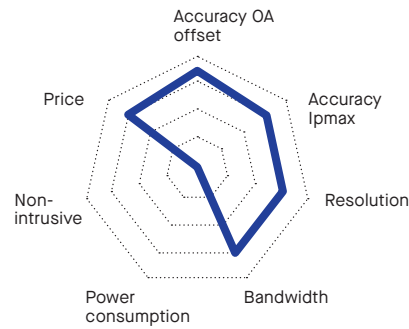

Fluxgate

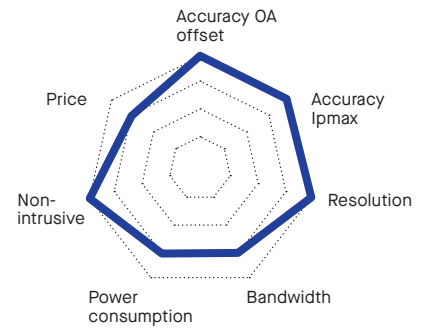

Open loop technology

Open loop sensors use a Hall effect integrated circuit. The magnetic density, contributing to the rise of the Hall voltage, is generated by the primary current to be measured, which is supplied by a current source such as a battery or generator. HEV and EV include battery monitoring, starter generators, converters, electrical power steering, and motor drive applications.

Shunt technology

LEM shunt sensors, based on Ohm's Law with voltage drop across the shunt proportional to its current flow, measure both alternating currents (AC) and direct currents (DC). Low cost and high reliability, low resistance shunt sensors are a popular choice for current measurement. Smart shunt technology offers mechanical and electrical design suitable for both light and heavy duty applications with multiple batteries.

Fluxgate technology

LEM's fluxgate sensing head is made of an induction coil with particular characteristics. The core material has very high permeability and low remanence (H_c), enabling very fast transition between linear and saturated state. Energizing the coil with an alternative voltage makes the core go through a complete hysteresis loop. With a primary current flowing through the coil, the hysteresis loop is shifted. The measurement of this shift represents the primary current.

12V battery management systems

LEM develops galvanically-isolated current sensors dedicated to 12V battery management for standard internal combustion engines (ICE) and smart BMS for start-stop powertrains.

Solutions for ICE vehicles

LEM brings more than two decades of experience in 12V BMS for lead acid batteries and offers a leading product portfolio for standard ICE powertrains.

Solutions for start-stop vehicles

LEM offers a range of intelligent battery sensors that combine unique expertise in current sensing technologies with the experience acquired over the years in lead acid battery technologies.

12V battery sensor in vehicles

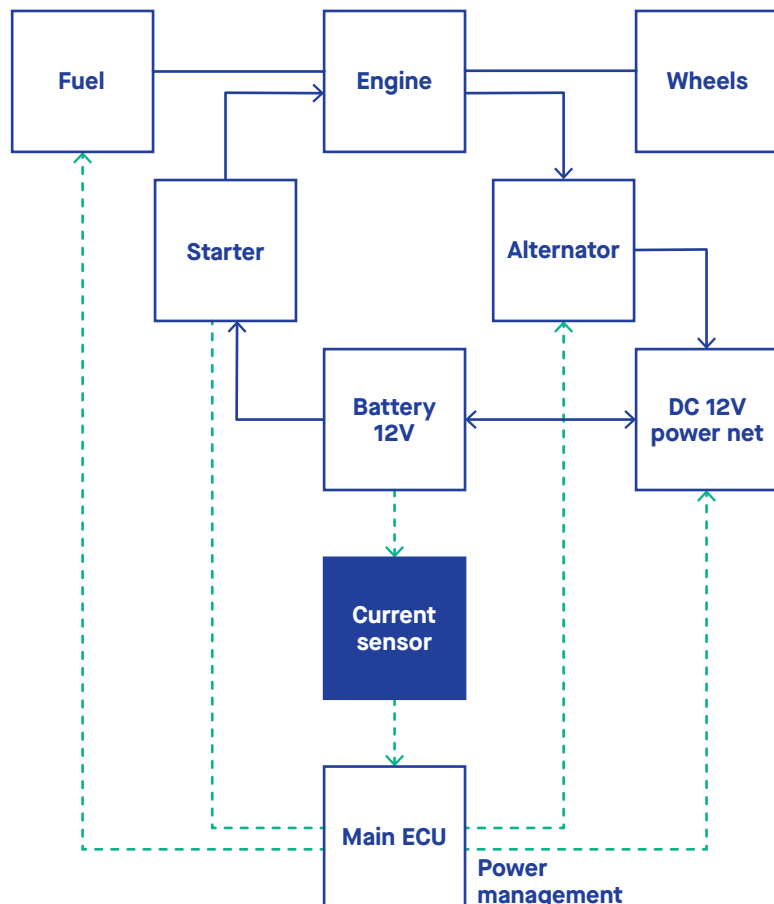

12V BMS sensor portfolio

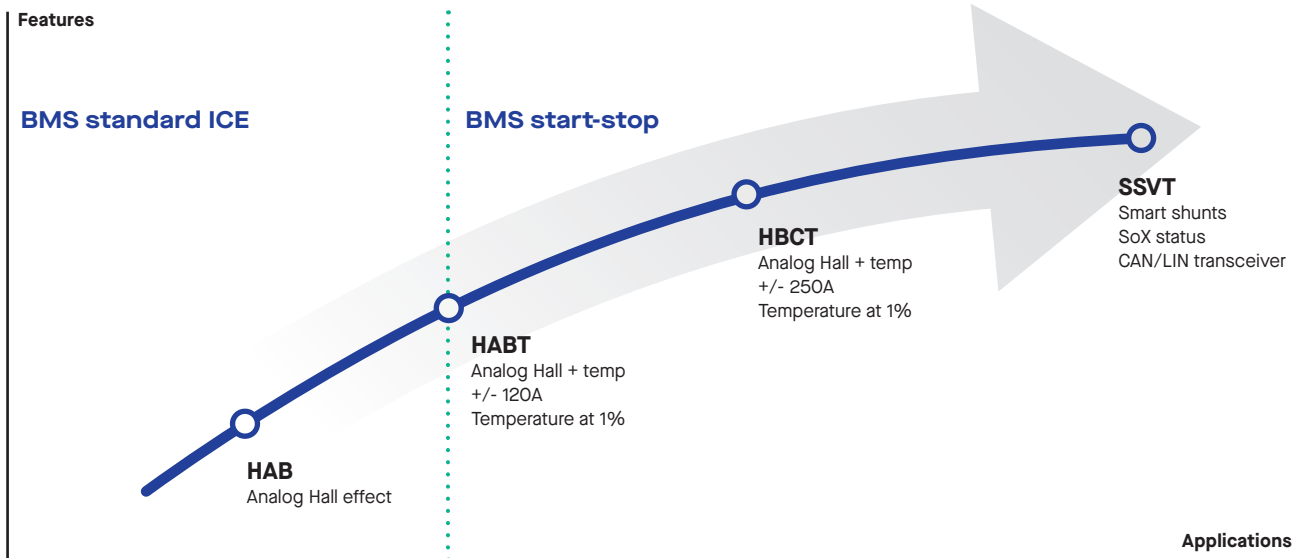

12V BMS specifications

Sensor	HAB	HABT	HBCT	SSVT
Technology	Open loop	Open loop + temp	Open loop + temp	Smart shunt
Current range max	+/- 400A	+/- 120A	+/- 250A	+/- 1500A
Output	Voltage/PWM	Voltage/PWM	Voltage	CAN/LIN SoX status
Global error @25°C	0,8%	0,8%	0,8%	0,5%
Overall accuracy (over T°C)	3,75%	3,6%	3,75%	1,5%
Offset current	+/- 200 mA	+/- 200 mA	+/- 350 mA	+/- 20 mA
Bandwidth (programmable)	1.1 kHz	1.1 kHz	1.1 kHz	1.1 kHz
Mounting type	Cable	Cable	Clamp	Clamp
Input voltage	+5V	+5V	+5V	+12V/+24V
Consumption	7 mA	7 mA	10 mA	12 mA

HV battery management systems

LEM high voltage battery pack BMS for hybrid and electric vehicles

Fluxgate technology

LEM brings a unique capability in fluxgate, the leading technology for high performance battery management that offers contactless solutions. The CAB series offers best-in-class accuracy (up to 0.1% and at I_p max), an offset at OA measurement as well as ASIL readiness which avoids the installation of a redundant sensor.

The CAB fluxgate products are embedded in the battery disconnection unit (BDU) or the battery pack of vehicles with electrified powertrains (xEV).

Hall open loop technology

LEM's broad portfolio of single range sensors combines high compactness and an integrated busbar design for cost effectiveness. LEM developed a high accuracy dual range sensor with a dedicated low range to drastically improve offset performances.

The LEM Hall-based products are suitable for the electronic measure of current in high power and low voltage applications with galvanic separation between the primary circuit (high power) and the secondary circuit (electronic circuit). LEM offers the choice between different ranges of current measure in the same housing while providing excellent accuracy and very good linearity, with low thermal offset and thermal sensitivity drifts.

Battery disconnecting unit architecture

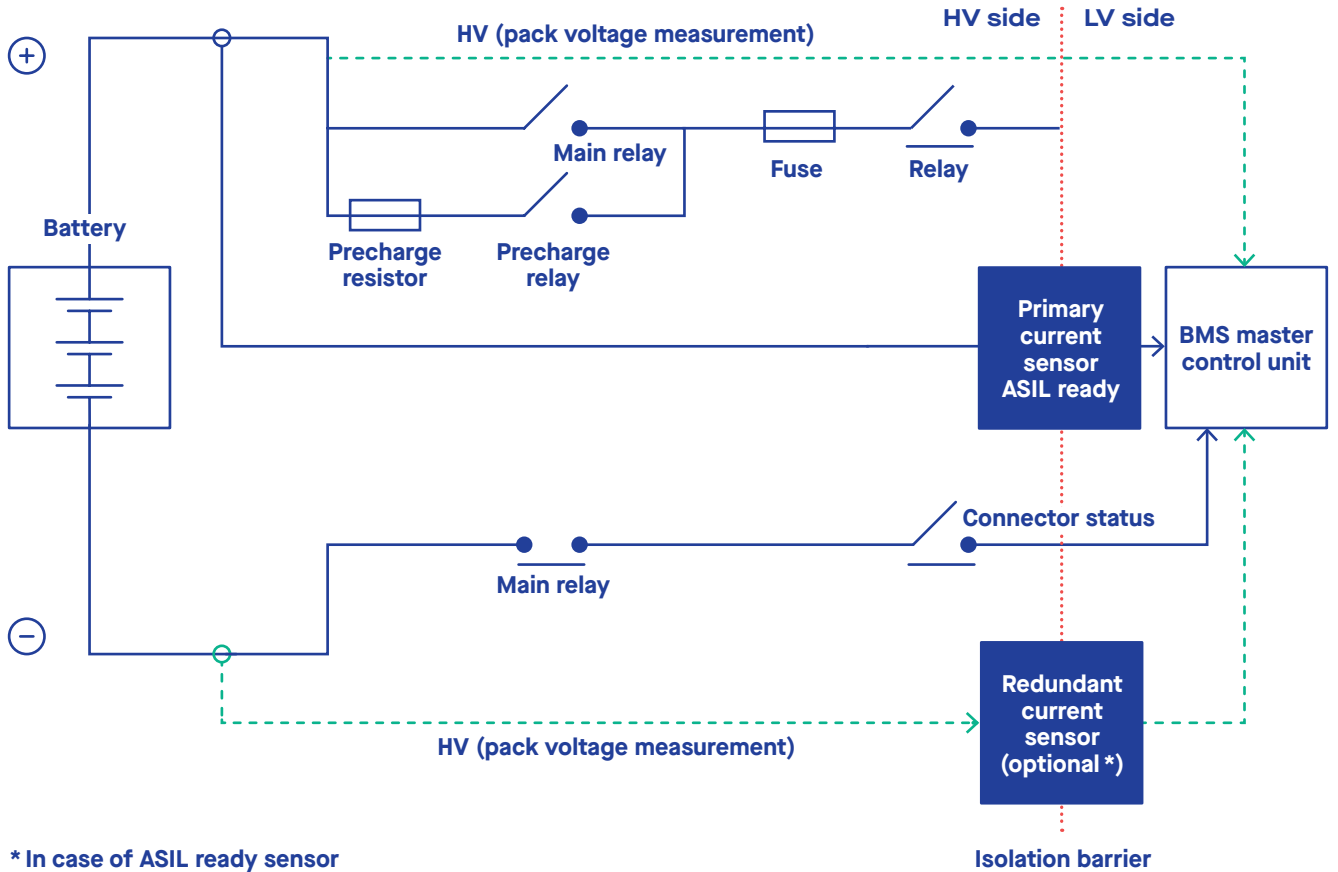

HV battery management systems

LEM high voltage battery pack BMS for hybrid and electric vehicles

From mid power to ASIL ready performance

LEM provides a portfolio of solutions featuring a wide range of power levels that complies with the highest requirements of performance and safety.

HV BMS sensor specifications

Sensor	HSW	HAH1BVW	HSNBV	DHAB
				
Technology	Open loop	Open loop	Open loop dual range	Open loop dual range
Current range max	+/- 1000A	+/- 1200A	+/- x00A +/- 1000A	+/- x00A +/- 1000A
ASIL readiness	-	-	-	-
Output	Voltage single	Voltage single/dual	Voltage single/dual	Voltage dual
Global error @25°C	0,5%	0,8%	0,5% (single)	0,8% (single)
Overall accuracy (over T°C)	2,0%	2,0%	2,0%	2,8%
Bandwidth (programmable)	1,1 kHz	1,1 kHz	1,1 kHz	1,1 kHz
Mounting type	Busbar	Busbar	Integrated busbar	Cable/Busbar
Input voltage	+5V	+5V	+5V	+5V
Consumption	7 mA	8/16 mA	Single 7 mA Dual 14 mA	16 mA

HV BMS sensor portfolio

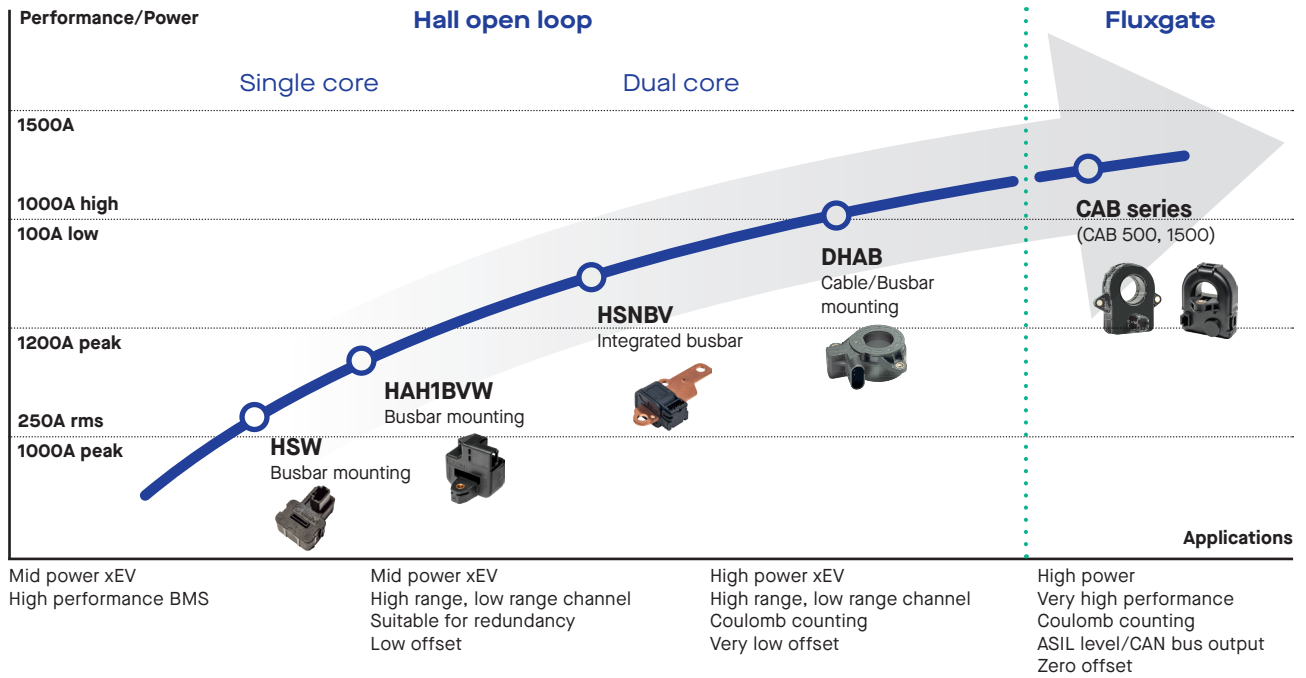

CAB 500



Fluxgate

+/- 500A

-

CAN/LIN

0,1%

0,5%

100 Hz

Cable/Busbar

+12V

40 mA (0A)
130 mA
(@500A)

CAB 1500



Fluxgate

+/- 1500A

-

CAN/LIN

0,1%

0,5%

100 Hz

Busbar

+12V

40 mA (0A)
500 mA
(@1500A)

CAB 500 SF



Fluxgate

+/- 500A

ASIL B

CAN/LIN

0,1%

0,5%

100 Hz

Cable/Busbar

+12V

40 mA (0A)
130 mA
(@500A)

CAB 1500 SF



Fluxgate

+/- 1500A

ASIL C

CAN/LIN

0,1%

0,5%

100 Hz

Busbar

+12V

40 mA (0A)
500 mA
(@1500A)

Motor control

Maximum flexibility for power inverter applications

LEM provides a broad, versatile range of sensors that enable flexible design for various systems: gate driver boards, power modules, integrated busbar and standard busbar mounting.

Electric and hybrid vehicle power motors (few kW to hundreds kW) use multiphase inverters to drive the traction and generator motors with a high degree of precision and reliability.

LEM offers standard and customized solutions to fit specific mechatronic requirements.

Motor inverter architecture

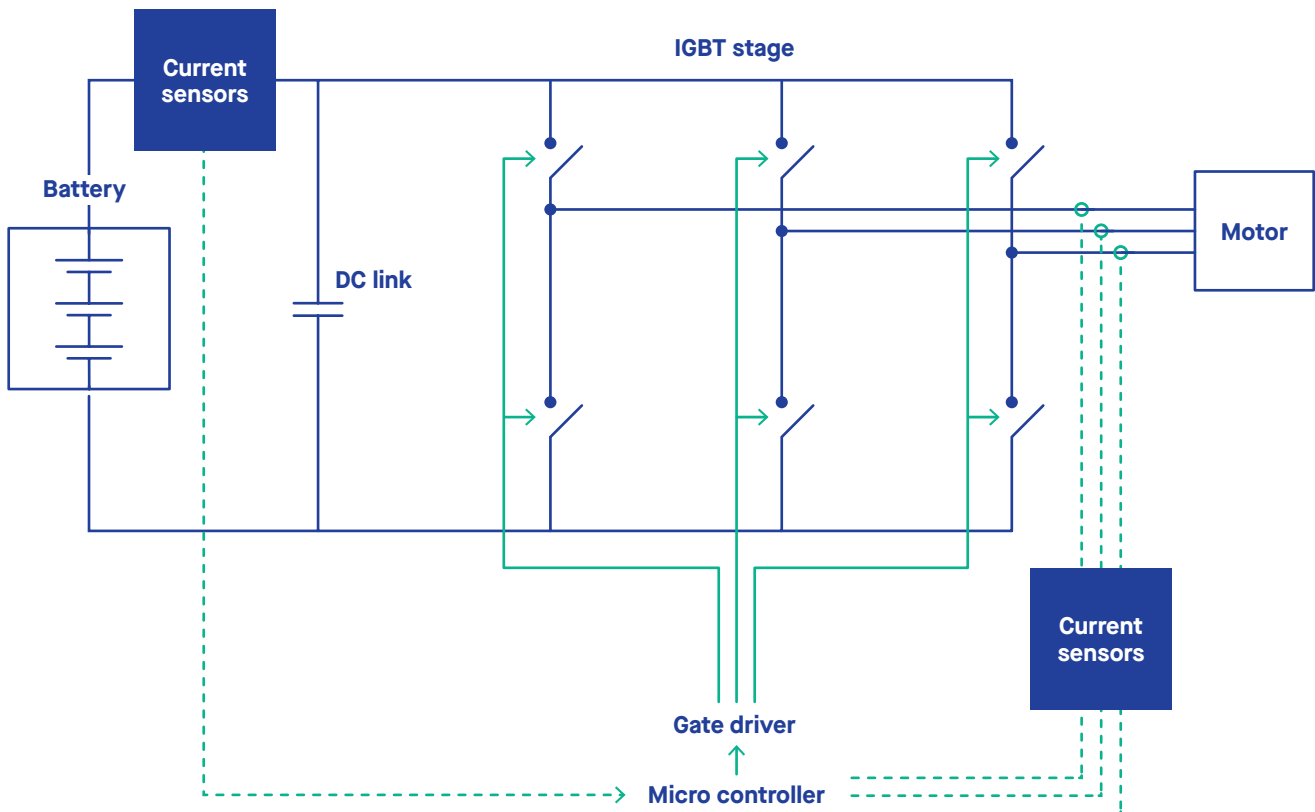

For low to high power inverters (MHEV to BEV)

- Integrated current sensing technologies and PCB mounted sensors

For mid to high power inverters (HEV to BEV)

- Single busbar mounted sensor legacy family
- Integrated busbar sensor for compactness, improved performance and easy assembly

For high power inverters (BEV)

- Multiphase sensors to improve system integration
- ASIL ready features

Motor control sensor portfolio

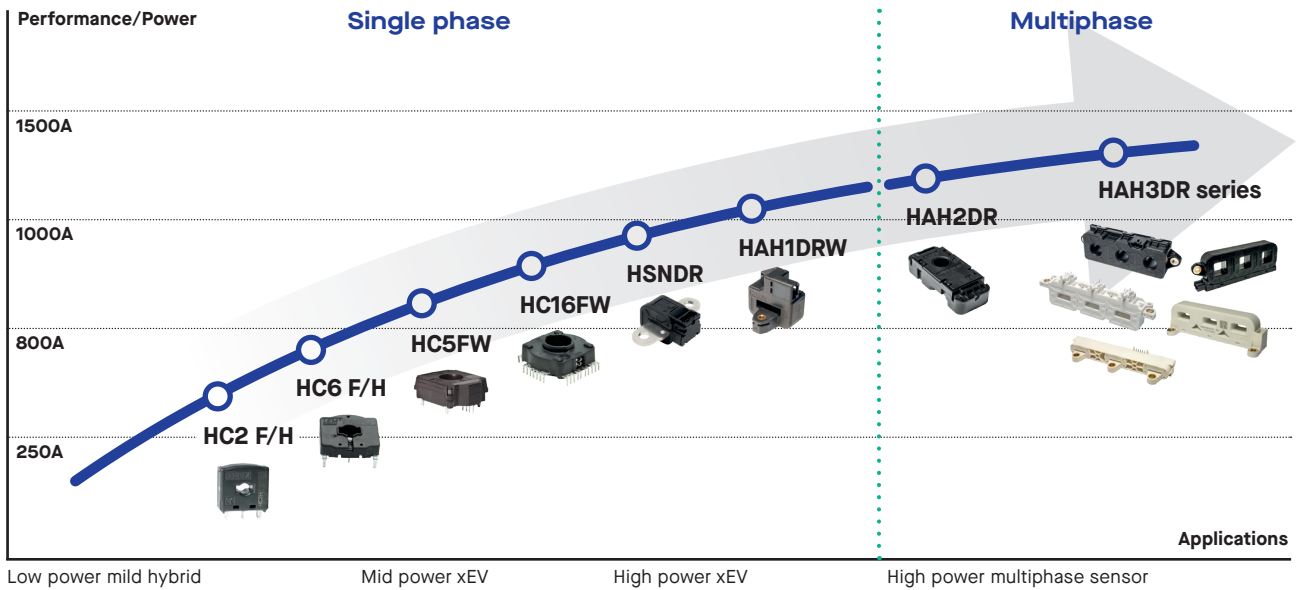

Motor control







Single phase and multiphase sensors

LEM offers a wide range of solutions for all inverters



- PCB mounted sensors
- Busbar mounted
- Integrated busbar
- Multiphase sensors
- Reference design sensors *



* Infineon hybrid pack HAH3DR S07 Series

Single phase sensor specifications

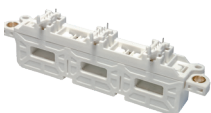
Sensor	HC2F/H	HC6F/H	HC5FW	HC16FW	HSNDR	HAH1DRW
						
Current range max	1 phase +/- 250A	1 phase +/- 800A	1 phase +/- 900A	1 phase +/- 1600A	1 phase +/- 1200A	1 phase +/- 1500A
Aperture type (size, compatibility)	Busbar (7,2 x 2,5 mm) ø 4,6 mm	Busbar (10,5 x 4,2 mm) ø 7,5 mm	Busbar ø 12,5 mm	Busbar (20,5 x 6 mm)	Integrated busbar (customization)	Busbar (20,5 x 6 mm)
Output type	Trough-hole PCB voltage	Trough-hole PCB voltage	Trough-hole PCB voltage	SMD or Trough-hole PCB Voltage	Molex connector voltage	Tyco connector voltage
Accuracy @25°C	1,2%	1,2%	1,2%	1,2%	1,25%	2%
Overall accuracy (over T°C)	3,25%	3,25%	3,25%	3,25%	3,2%	3,75%
Bandwidth	50 kHz	50 kHz	50 kHz	50 kHz	50 kHz	50 kHz
Input voltage	+5V	+5V	+5V	+5V	+5V	+5V
Consumption typical	15 mA	15 mA	15 mA	30 mA	15 mA	15 mA

Multiphase sensor specifications

Sensor	HAH2DR	HAH3DR SO0	HAH3DR SO3 SPx	HAH3DR SO6
				
Current range max	2 phases +/- 650A	3 phases +/- 900A	3 phases +/- 900A	3 phases +/- 900A
Aperture type (size, pitch, compatibility)	Busbar (13,8 x 2,3 mm) Pitch 44 mm	Busbar (14,5 x 5,5 mm) Pitch 30 mm	Busbar (15,5 x 7,5 mm) Pitch 38,5 mm	Busbar (15,5 x 5,5 mm) Pitch 38,5 mm
Output type	Voltage JAM connector	Voltage PCB mounted	Voltage Hirose connector	Voltage Molex connector
Accuracy @25°C	2%	2%	2%	2,5%
Overall accuracy (over T°C)	3,2%	3,5%	3,5%	4,25%
Bandwidth	50 kHz	50 kHz	50 kHz	50 kHz
Input voltage	+5V	+5V	+5V	+5V
Consumption typical	15 mA/phase	15 mA/phase	15 mA/phase	15 mA/phase

Sensor	HAH3DR SO7 SPx	HAH3DR SOA	HAH3DR SOC
			
			
Current range max	3 phases +/- 1200A	3 phases +/- 1500A	2-3 phases +/- 800A
ASIL readiness	ASIL B/C	-	-
Aperture type (size, pitch, compatibility)	Infineon hybrid pack long/short tab (14,5 x 1,5 mm) Pitch 47 mm	Busbar (ø 14,5 mm) Pitch 34 mm	Busbar (14,5 x 5,5 mm) Pitch 30 mm
Output type	Voltage pressfit	Voltage Molex connector	Voltage pin soldering
Accuracy @25°C	2%	1,2%	1,25%
Overall accuracy (over T°C)	3,2%	3,25%	3,25%
Bandwidth	50 kHz	50 kHz	50 kHz
Input voltage	+5V	+5V	+5V
Consumption typical	15 mA/phase	15 mA/phase	15 mA/phase

Charging systems

LEM offers dedicated technologies for charging systems to support transfer energy subsystems from AC to DC and DC to DC with high and low voltage applications.

Low current applications

LEM has semiconductor based solutions for low current applications from 10A to 200A_{rms}. Developed with cutting edge coreless technology, these products offer isolated high performance sensing in semiconductor packages. Easy to use and integrate, they are convenient for applications requiring high power density or very low footprint on current sensing function such as OBC, DCDC, EPS, BSG.

Charging systems sensor portfolio

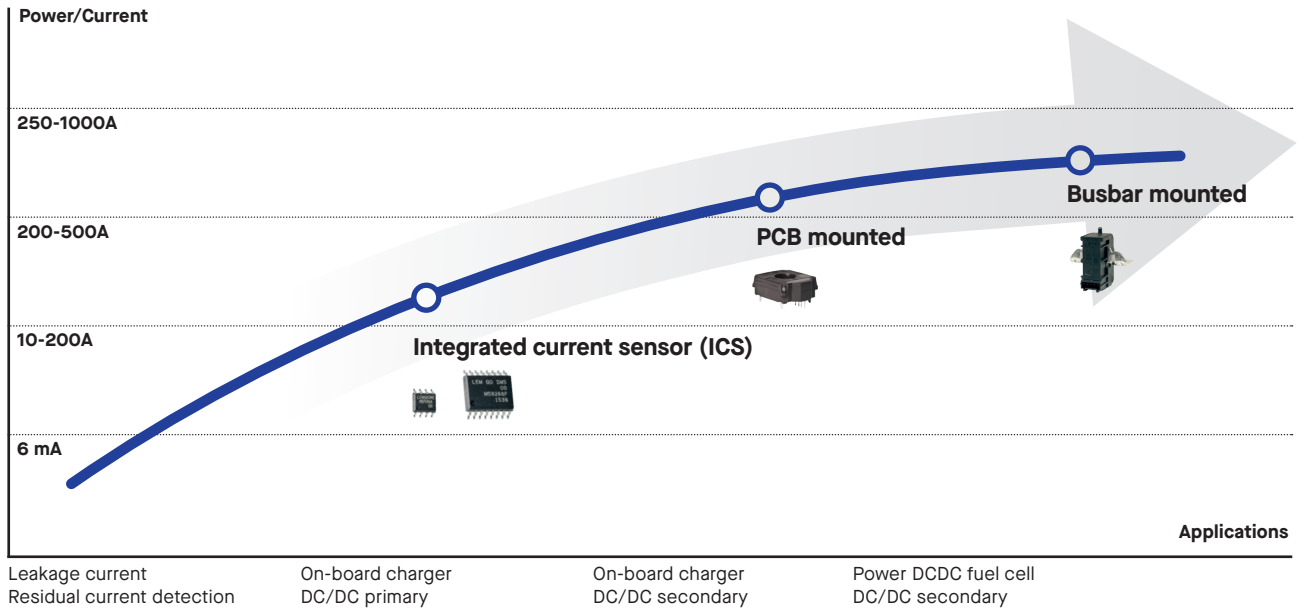

Bidirectional on-board charger architecture

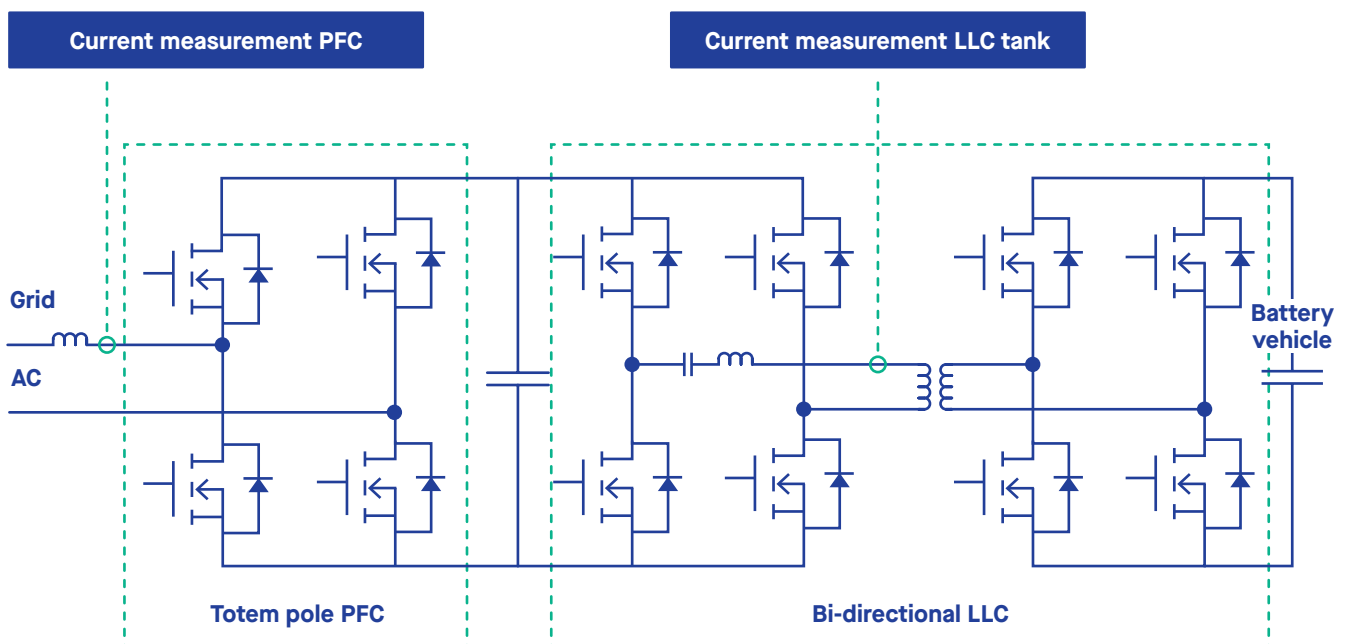

Charging systems

High efficiency power management is key to more efficient systems and longer driving range.

With increase of accuracy and bandwidth lead by system power density increase, LEM supports a wide range of sensors for all applications:

Integrated Current Sensors (ICS)

Hall based SMD sensors for low to mid current (below 200A peak)





PCB mounted sensors

For busbar current measurements for mid to high current (200A to 2000A peak)



Busbar mounted sensors

For high power applications

PCB and busbar mounted sensor specifications

Sensor	HC2 F/H	HC5FW	HSNDR	HAH1DRW	HAM
					
Technology	Open loop	Open loop	Open loop	Open loop	Open loop
Current range max	+/- 250A	+/- 900A	+/- 1200A	+/- 1500A	+/- 300A
Output	Voltage	Voltage	Voltage	Voltage	Voltage
Accuracy @25°C	1,2%	1,2%	1,25%	2%	2%
Overall accuracy (over T°C)	3,25%	3,25%	3,25%	3,75%	3,2%
Bandwidth	50 kHz	50 kHz	50 kHz	50 kHz	500 kHz
Mounting type	Trough-hole PCB	Trough-hole PCB	Integrated busbar	Busbar	Integrated busbar
Input voltage	+5V	+5V	+5V	+5V	+5V
Consumption	15 mA	15 mA	15 mA	15 mA	15 mA

Integrated current sensor specifications

Sensor	GO SME	GO SMS	HMSR
			
Current range RMS	10-20A rms	10-30A rms	10-30A rms
Peak current	50A peak	75A peak	75A peak
Isolation	2,5kV	3kV	4,9kV
Accuracy (25°C - over T°C)	1,3% - 3%	1,3% - 3%	1% - 2%
Output type	Analog	Analog	Analog
Vref/Ratiometric	Vref	Vref	Ratio/Vref
Temp. range	-40°C to 125°C	-40°C to 125°C	-40°C to 150°C
Bandwidth	300 kHz	300 kHz	300 kHz
Supply voltage	3,3V/5V	3,3V/5V	3,3V/5V
AECQ100	Yes	Yes	Yes
Target applications	OBC primary, DCDC	OBC primary, DCDC	OBC, DCDC
Package	SOIC 8	SOIC 16	SOIC 16 (footprint compatible)

Contact

North America

LEM USA inc. (Detroit)
28221 Beck Road, Suite A4
Wixom, MI 48393
USA
Tel. +1 248 324 0395
Fax +1 248 324 0397
autosales-na@lem.com

Europe

LEM Europe GmbH
Frankfurter Strasse 74
64521 Gross-Gerau
Germany
Tel. +49 6152 930 10
Fax +49 6152 846 61
leu-de@lem.com

China

LEM Electronics (China) co. Ltd.
No. 28, Linhe str. Linhe
Industrial development zone
Shunyi district, Beijing
China
Post code: 101300
Tel. +86 10 89 45 52 88
Fax +86 10 80 48 43 03
+86 10 80 48 31 20
autosales-china@lem.com

South Korea

LEM Management Services Sàrl,
Branch Korea
(Seocho-dong, Wonil Bldg)
1-3F(311) 10
Nambushuhwan-ro 333-gil
Seocho-gu
Seoul, Korea

Japan

LEM Japan k.K.
2-1-2 Nakamachi
Machida-Tokyo 194-0021
Japan
Tel. +81 42 725 81 51
Fax +81 42 728 81 19
autosales-japan@lem.com

Rest of the world

LEM International SA
8, Chemin des Aulx
1228 Plan-les-Ouates
Switzerland
Tel. +41 22 706 13 92
Fax +41 22 706 13 28
automotive_sales@lem.com

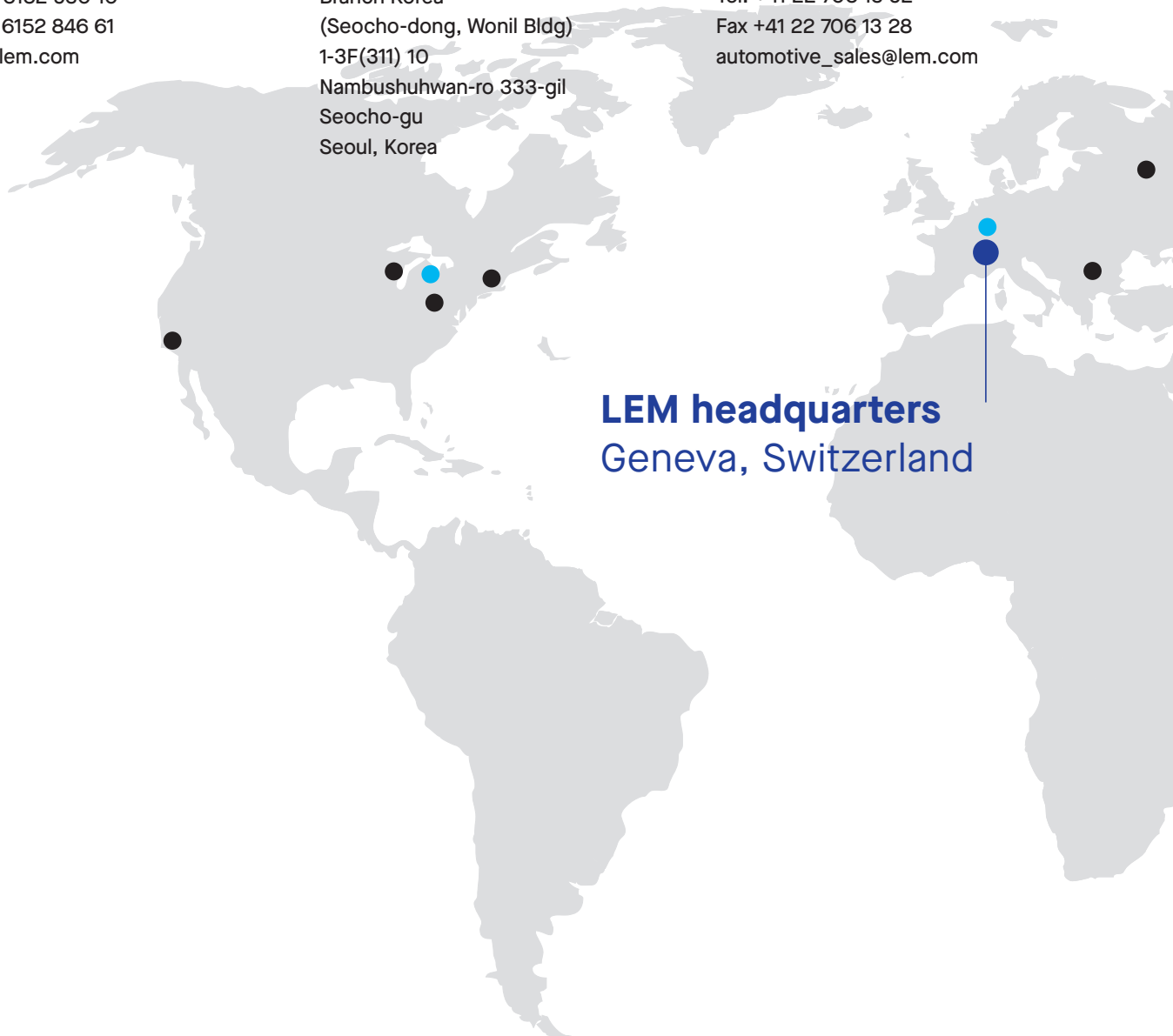

LEM headquarters
Geneva, Switzerland

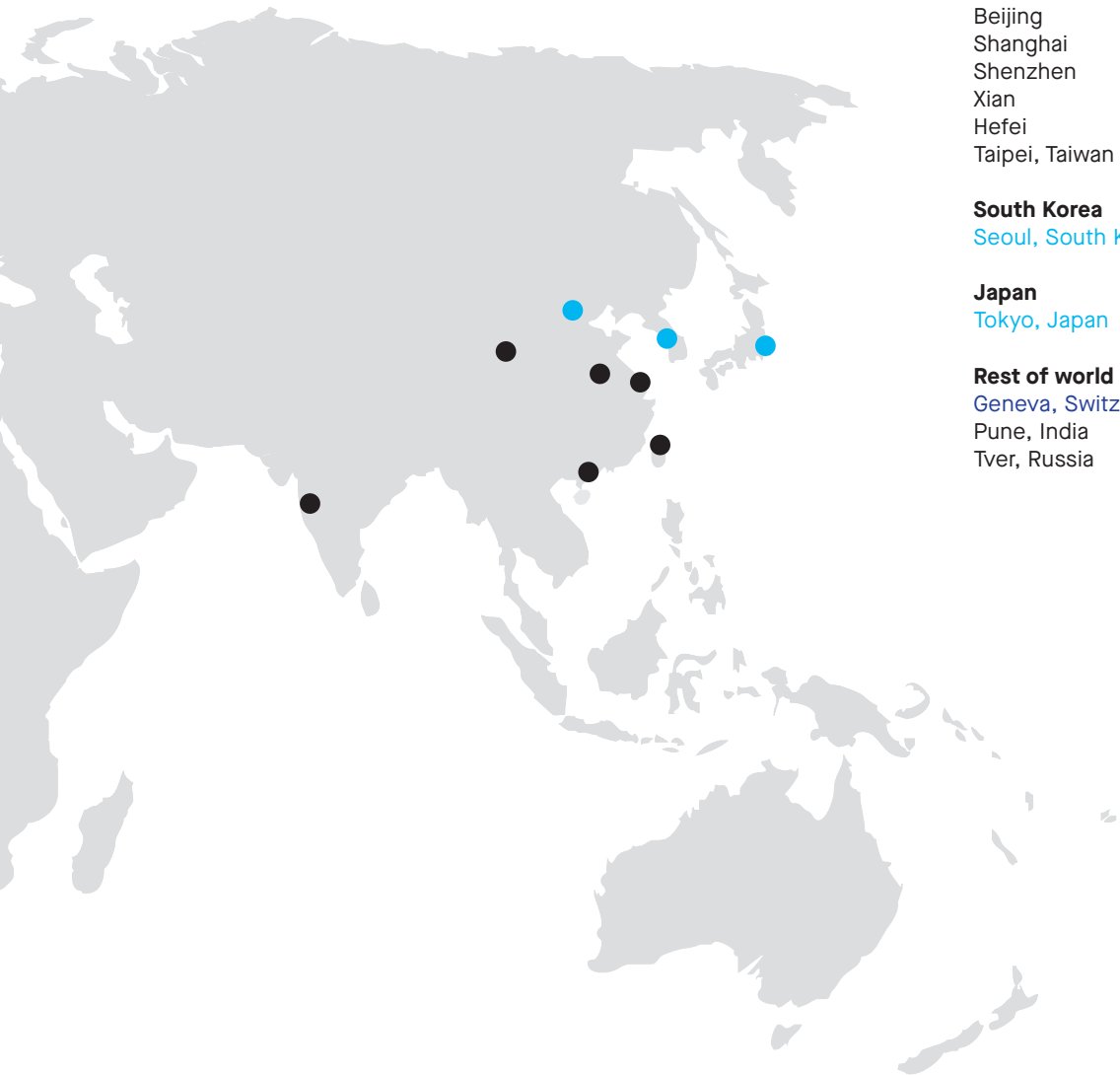

North America

- Detroit MI
- Milwaukee WI
- Columbus OH
- Amherst MA
- Los Angeles CA

Europe

- Frankfurt, Germany
- Vienna, Austria
- Brussels, Belgium
- Randers, Denmark
- Paris, France
- Padova, Italy
- Skelmersdale, UK
- Lyon, France
- Sofia, Bulgaria

China

- Beijing
- Shanghai
- Shenzhen
- Xian
- Hefei
- Taipei, Taiwan

South Korea

- Seoul, South Korea

Japan

- Tokyo, Japan

Rest of world

- Geneva, Switzerland
- Pune, India
- Tver, Russia

	Sales	R&D	Production
North America			
Detroit MI	●		
Milwaukee WI	●		
Columbus OH	●		
Amherst MA	●		
Los Angeles CA	●		
Europe			
Frankfurt, Germany	●		
Vienna, Austria	●		
Brussels, Belgium	●		
Randers, Denmark	●		
Paris, France	●		
Padova, Italy	●		
Skelmersdale, UK	●		
Lyon, France		●	
Sofia, Bulgaria	●	●	●
China			
Beijing	●	●	●
Shanghai	●		
Shenzhen	●		
Xian	●		
Hefei	●		
Taipei, Taiwan			
South Korea			
Seoul, South Korea	●		
Japan			
Tokyo, Japan	●		●
Rest of world			
Geneva, Switzerland	●	●	●
Pune, India	●		
Tver, Russia	●		●

LEM

Life Energy Motion

